

1000F Wheeled Sprinkler Cart

1000F



Thank you for purchasing the 1000F Wheeled Sprinkler Cart from BigSprinkler.com™. This sprinkler cart is an excellent and affordable option for irrigating a variety of areas such as a small or large lawn, gardens, playgrounds, natural and artificial sports fields, horse arenas or round pens for dust control, and much more. Our carts are fabricated with care and precision in our Yukon, Oklahoma facility with quality heavy duty components.

The following manual is a guide for assembly, setup, and operation of your new BigSprinkler™ cart. Please read and follow all instructions carefully.

We also offer accessories such as 3/4" garden hoses, larger pre-made hose kits with quick connects for easy hook-up and booster pumps that will greatly enhance pressure and performance for your sprinkler cart.

Cart Assembly Instructions

Please read this manual carefully and follow all safety and assembly instructions below to ensure that your cart is assembled correctly and operates properly upon start-up. If you have any questions please call 855-805-7901.



Safety



Safety is the main priority and failure to follow these instructions may cause serious injury. BigSprinkler.com is not responsible for product failure, property damage, or personal injury if these procedures and operation instructions are not followed.

- **Beware of electric power lines**

Irrigation water should never contact electric power lines or any other power source. Never let any part of the sprinkler cart or any irrigation fittings or pipe come in contact with an electric power source.

- **Use caution up close to operating sprinkler heads**

Pressurized water from the sprinkler head could cause serious damage to people or objects. Never allow small children to play close to operating sprinkler heads!



Cart Assembly Instructions

STEP 1) BODY & AXLE ASSEMBLY

First, assemble the axle to the main body. Place (1) flat washer on each of the threaded ends of the u-bracket on the body. Next, align and insert the threaded ends of the u-bracket on the main body through the 2 holes in the axle. Then, secure the axle to the body by placing (1) flat washer, (1) lock washer and (1) 1/4" acorn nut on each of the threaded ends. Tighten using a 9/16" wrench.

NOTE: Do not adjust the u-bracket mounted on the body. It is properly preset from the factory.

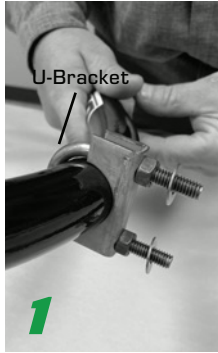

STEP 2) MOUNTING WHEELS ONTO THE AXLE

Place the shoulder bolt through the middle on the front side of the wheel as shown in the image. Next, continue to pass the threaded end through the hole at the end of the axle tab. To secure the wheel, thread the 3/8" lock nut on the end of the bolt and tighten with a 9/16" wrench and the provided 1/4" Hex Tool. Tighten until it stops. Repeat the same steps for the other wheel.



Cart Assembly Instructions

STEP 3) INSTALLING THE IMPACT SPRINKLER HEAD

First, remove the thread protector cap to expose the taped threads, *do not remove white thread tape*. Place the bottom of the sprinkler on top of the threads and slowly turn clockwise. **NOTE:** Make sure to begin slowly so that the threads start correctly. If they are cross threaded, it will result with the threads being damaged on both the cart and sprinkler.

Secure sprinkler head by tightening with a large enough crescent wrench or pipe wrench. **CAUTION:** Only tighten sprinkler head by placing wrench on the lower base area of the sprinkler head to avoid damage to the upper portion of the sprinkler.

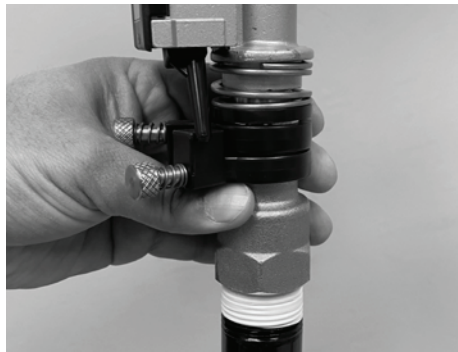
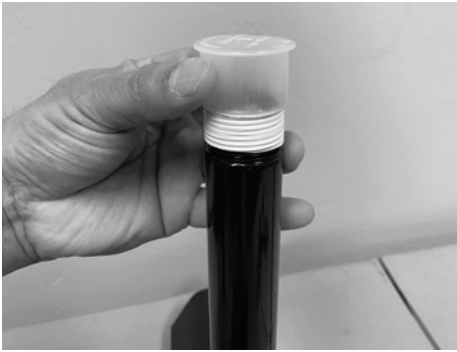

STEP 4) Position sprinkler cart in area to be watered and attach cart to your hose. Your sprinkler cart is now ready for operation. **NOTE:** Always run water through your garden hose to flush out before hooking it up to your sprinkler cart. Doing so will prevent anything from clogging the sprinkler when running.

To make adjustments to the impact sprinkler please refer to the "Impact Sprinkler Adjustment" page.

1000F Sprinkler Cart Performance Chart

Nozzle Size	PSI	GPM	Jet Length/Feet (One Direction)	Wetted Circle (Diameter/Feet)
5 mm (0.20")	22	5.3	42	84
	29	6	46	92
	44	7	50	100
	58	9	54	108
6 mm (0.24")	22	7	43	86
	29	8.5	48	96
	44	10	54	108
	58	12	58	116
7 mm (0.28")	22	10	46	92
	29	11	50	100
	44	14	56	112
	58	16	61	122
9 mm (0.35")	22	16.4	50	100
	29	19	54	108
	44	23	61	122
	58	26	64	128

Notice: These specifications are to be used as a guide only and have been calculated at zero wind conditions. Performances can vary due to pressure, terrain, wind, and field conditions.

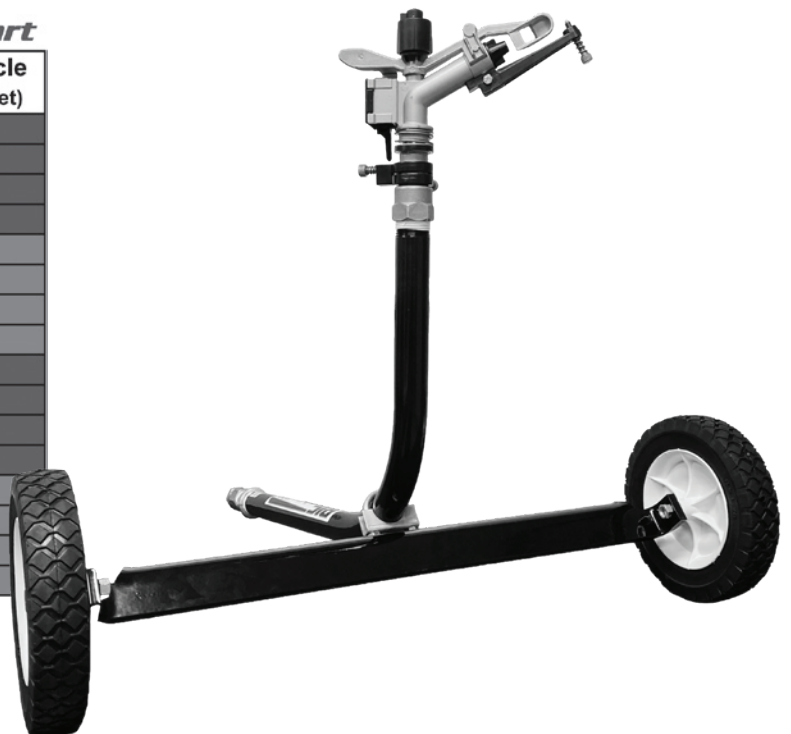

Sprinkler Head Settings

The sprinkler head supplied with your cart is a fully adjustable sprinkler that will operate in a full circle pattern or any part of a circle by adjusting the stops at the base of the sprinkler. Refer to the instructions below to set sprinkler head to the desired operating pattern.

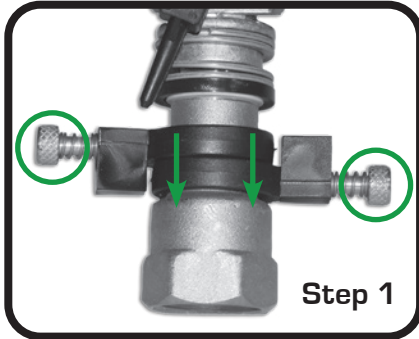

Step 1

Step 1) For full circle operation, loosen sprinkler stop, set screws as shown, and slide stops all the way down the brass sprinkler base so they do not contact the reverse lever on the back of the sprinkler head. Re-tighten set screws to hold the stops in place. This will allow the sprinkler head to operate in a full circle mode.

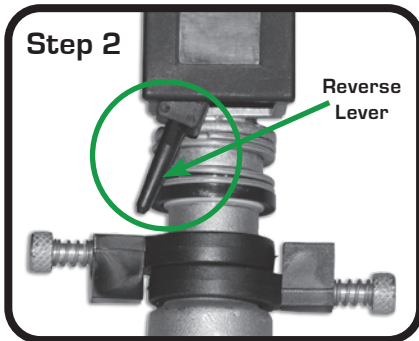

Step 2

Step 2) IMPORTANT: REVERSE VS. FORWARD MODE

If you set the sprinkler head for full circle operation, the reverse lever will either stay to the right or left for reverse or forward mode. Typically when using the sprinkler in full circle operation, you will want the sprinkler to be set in forward mode or a clockwise operating direction. For this to occur, you want the reverse lever at the back of the sprinkler to be over to the left as shown. If the lever is set to the right, the sprinkler will be in reverse mode. In reverse mode, the sprinkler will operate rapidly in a counterclockwise direction and your distance of throw will be less than it would be in forward mode.

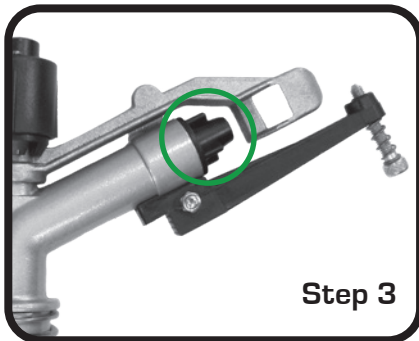

Step 3

Step 3) Nozzles Supplied: Your sprinkler head is supplied with a set of nozzles that are interchangeable to meet your water source's capability. It is shipped with the smallest nozzle installed. If your water system operates the small nozzle adequately then, you may move up to a larger nozzle size for increased performance. The nozzle sizes listed on your supplied performance charts have gallons per minute output that tally at various pressures and wetted patterns that correspond. This may be a trial and error exercise to determine which nozzle size gives you the best desired performance when matched to your water source's capability. You may feel more comfortable consulting your servicing well dealer for help with your system's capability if desired performance is not being met.

It may also be necessary to purchase a booster pump from our pump section of BigSprinkler.com if pressure boosting is needed. best desired performance when matched to your water source's capability.

Accessories



Garden Hose



Fittings



Booster Pumps

Warranty

LIMITED WARRANTY AND REMEDY:

WARRANTY

BigSprinkler.com™ warrants to the original purchaser only of the products described in the face hereof as of the date of the original invoice, that the product is merchantable and free from defects in material and workmanship.

Warranty shall be provided by the original manufacturer of products sold on BigSprinkler.com™ for the length of time specified by the manufacturer of the given product.

Sprinkler stands - 1 year

Sprinkler heads - 1 year

REMEDY

If BigSprinkler.com™ determines that the above warranty was breached with respect to any part or component provided by the manufacturer of the product (and if all conditions set forth below have been satisfied) then, BigSprinkler.com™ will (at BigSprinkler.com™'s option) provide purchaser a refund of the purchase price less the freight costs to or from the customer, or provide a replacement product of the same kind.

All remedies provided herein are for goods only, no labor or freight allowance for return goods is implied.

This warranty extends only to the original purchaser of products purchased from BigSprinkler.com™.

CONDITIONS TO ENFORCEABILITY AND CLAIMS:

1. Product has been maintained and operated within the guidelines outlined in the manufacturer's product guide and maintenance manual.
2. Product warranty shall be considered void if any component or function of the equipment has been altered in any form other than what has been provided or intended by the original product manufacturer.
3. Any return must be submitted on form provided by BigSprinkler.com™ in writing immediately and in no event longer than 20 days from occurrence. You can reach our sales department through the "contact us" form on our website should such an event occur.
4. Purchaser must return all goods within 30 days of BigSprinkler.com™'s authorization date, that have been determined by BigSprinkler.com™ to be defective to the Purchaser with Purchaser being responsible for freight.

LIMITATIONS:

BigSprinkler.com™ or its affiliates shall not be liable for any incidental or consequential damages (including but not limited to, damages for injury to the person, property or lost turf, crops or profits) by reason of any defect in the products sold or its manufacture, design, or function.